

Report on

Evaluation of Stetzer Filters

by

**Greg Gajda, Art Thansandote Ph.D., Eric Lemay, D. Lecuyer, W
Gorman and James McNamee, Ph.D.**

**Consumer and Clinical Radiation Protection Bureau
Health Canada**

May 11, 2006

Canada 

Background

Recent media attention has focused on the practice of installing electrical filters (called Stetzer filters) on the 120 V, 60 Hz electricity supply in the home. The filters are purported to clean so-called “dirty electricity” and are said to incur health benefits such as lowering blood sugar, relieving or reducing symptoms of multiple sclerosis and treating attention deficit hyperactivity disorder (ADHD) in school children [Havas and Stetzer, 2004].

The dirty electricity referred to in some of the literature is the “*electrostatic fields that vary rapidly in a random or noiselike pattern*” whereby “*the power distribution wires are the antennas and grounds that couple these noise-like signals to humans*” [M. Graham, 2002 in www.alternative-doctor.com/allergydotcom/electricalpollution3.htm]. The frequencies that are considered to be the most damaging by some sources are in the range 4kHz to 100 kHz [www.getpurepower.ca/dirtyelectricity.html]. The functioning of the filter is claimed to be effective in this band “*while there is decreasing filtering action above 100 kHz and below 4 kHz.*” [ibid.] .

The accompanying Graham-Stetzer Microsurge meter plugs into the wall outlet and is claimed to measure the “*average magnitude of the changing voltage as a function of time (dV/dt), which naturally emphasizes transients and other high frequency phenomena that change rapidly with time. The measurements of dV/dt read by the meter are defined as G-S (Graham-Stetzer) units (since no standard term is available). The G-S units are a measure of "harmful energy" which is a function of frequency, or more generally, rate of change of voltage or dV/dt .*” [www.stetzerelectric.com/filters/meter_sheet.html]

Purpose

The purpose of this investigation was to see the effects on the line voltage of the 60 Hz supply and load currents carried by the supply when a Stetzer filter is plugged-in, alone and in conjunction with household appliances. For appliances, we selected an incandescent light bulb, a fluorescent light and a home computer and CRT monitor.

No attempt was made to measure magnetic or electric field strengths since these are a function of a large number of physical parameters. The intention was only to see what effect the filters would have in “cleaning” the electricity supply as claimed in the promotional literature.

Methods

For all measurements, the set-up in Figure1 was implemented.

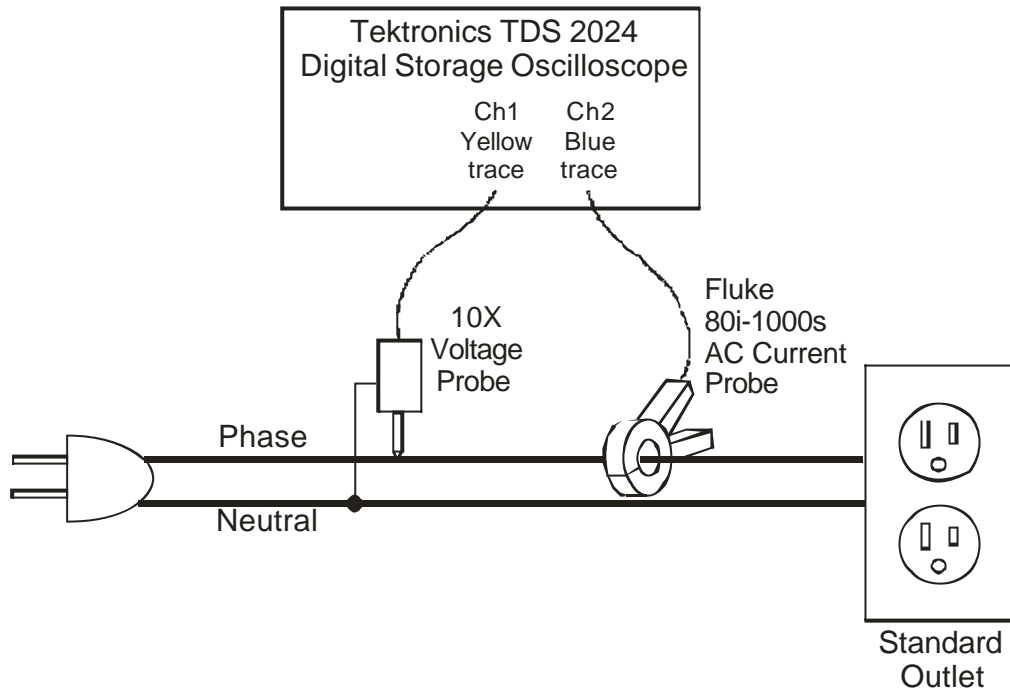

Figure 1, Set-up for measuring effects on line voltage and load currents.

An extension cord was modified so that a 10x voltage probe could be connected between the phase and neutral wires and a clamp-on AC current probe could be clamped around the phase wire. With this set-up, various combinations of loads and Stetzer filter could be connected together.

A digital storage oscilloscope (Tektronics TDS 2024) was used to take readings of voltage and current with respect to time and display them as oscillographs. It could also be used to record the frequency spectra of the voltage and current waveforms displayed on the screen using its built-in Fast Fourier Transform feature. Permanent recordings of the screen display were made with a digital camera, which will explain the slight distortions of the images.

Stetzer Filter Alone: Effect on line voltage and load current.

Measurements were performed to see what effect a Stetzer filter has on the line voltage and to observe the current passing through the filter (load current). This sequence of measurements was performed in the Electromagnetics laboratory of the Clinical and Consumer Radiation Protection Bureau.

Effect of Stetzer Filter on Line Voltage:

The effect of the filter on line voltage is shown in the next two figures (Figures 2 and 3) showing the frequency spectra before and after installing a Stetzer filter.

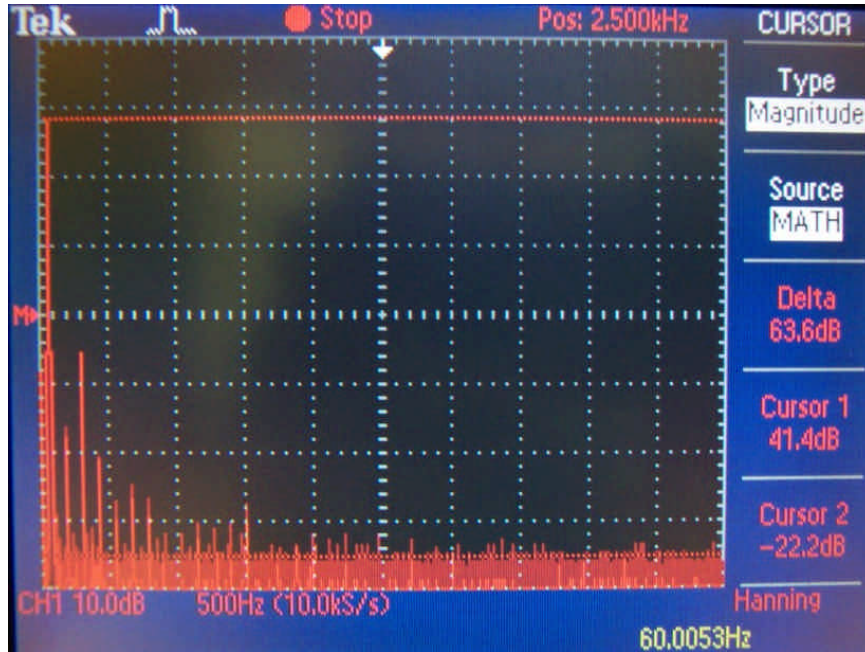

Figure 2, Spectrum of line voltage without Stetzer filter. The span of the plot is from approximately 50 Hz to 5 kHz. The large spectral line at the extreme left is the 60 Hz fundamental frequency of the line voltage.

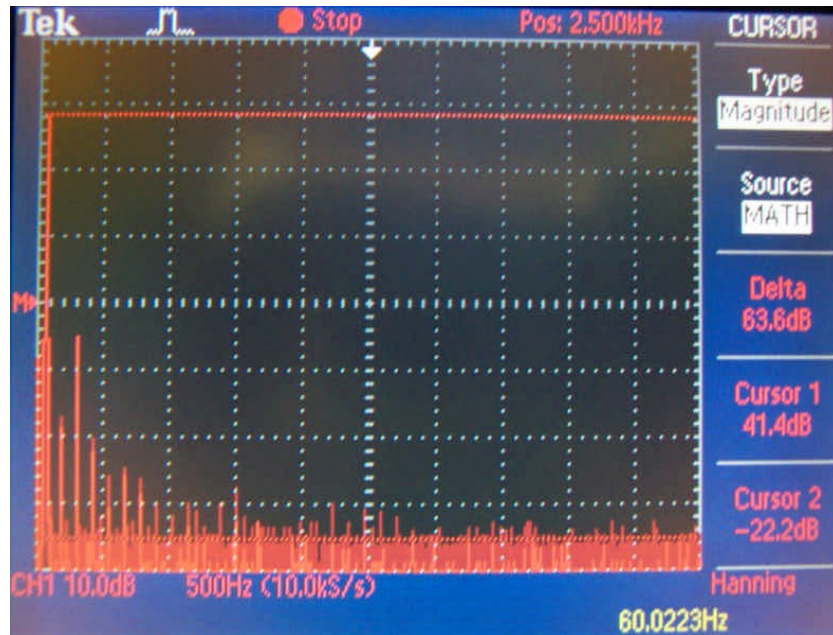

Figure 3, Spectrum of line voltage with a single Stetzer filter. The span of the plot is from approximately 50 Hz to 5 kHz.

Before plugging in the filter, a reading of the Stetzer meter gave a value of 121-128 GS units while after plugging-in the reading was 54-58 GS units. The line voltage spectral plots in Figures 2 and 3 show significant spectral lines at 180 Hz, 300 Hz and 420 Hz which are the 3rd, 5th and 7th harmonics of the 60 Hz fundamental. There does not appear to be any change in their amplitudes with or without the Stetzer filter present.

The effect of the Stetzer filter on the so-called “high frequencies” extending from 4 kHz to 100 kHz could not be evaluated in this circumstance because, for both cases, they were below the noise floor of the instrument used in this set-up. This was apparent when the line voltage signal was removed, the displayed high frequencies did not drop in amplitude (from the level of Cursor 2). (For this measurement the instrument display was set to “peak-hold” so that the peaks of high frequencies would be captured.) This illustrates that even without a Stetzer filter, the high frequency components of the line voltage were at least 63.6 dB below the amplitude of the fundamental at this location in the electricity supply. This translates to a factor of 1500 times lower than the fundamental in terms of voltage. (Note that this observation was valid for frequencies to 100 kHz although in Figures 2 and 3, only those up to 5 kHz are displayed.)

Characteristics of the Current Flowing Through a Stetzer Filter:

Because the Stetzer filter is a load on the electricity supply, it draws current through itself, which must be carried on the phase and neutral wires. While the literature accompanying the filters are correct in stating that the filters consume no energy from the

supply, they nevertheless add to the “apparent power” drawn from the supply and increase the net current flowing in the wires. An oscillograph of the load current (blue trace) and line voltage (yellow trace) of a single Stetzer filter is shown in Figure 4 below while the spectral plot of the load current waveform is shown in Figure 5.

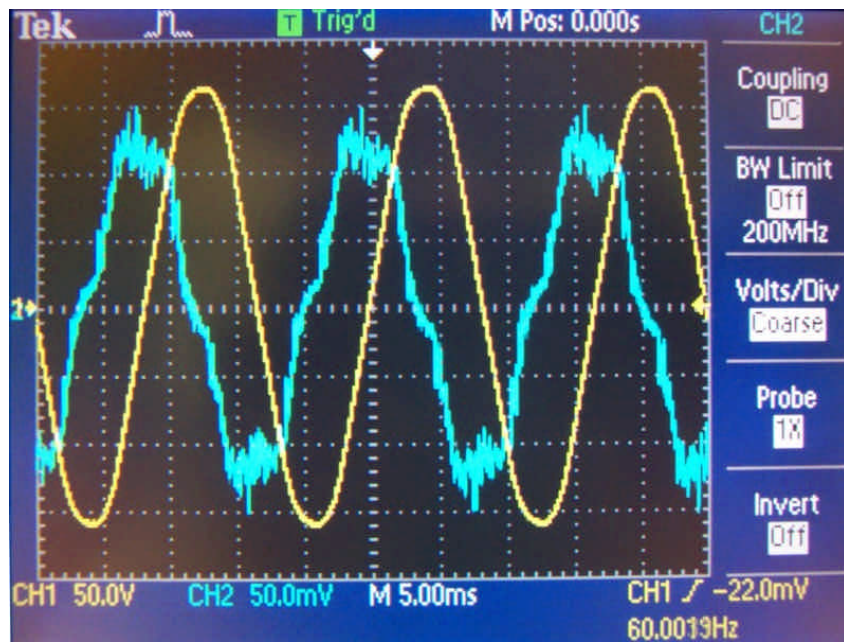

Figure 4, Line voltage and load current of single Stetzer filter. The yellow trace is the line voltage while the blue trace is the load current flowing through a single Stetzer filter.

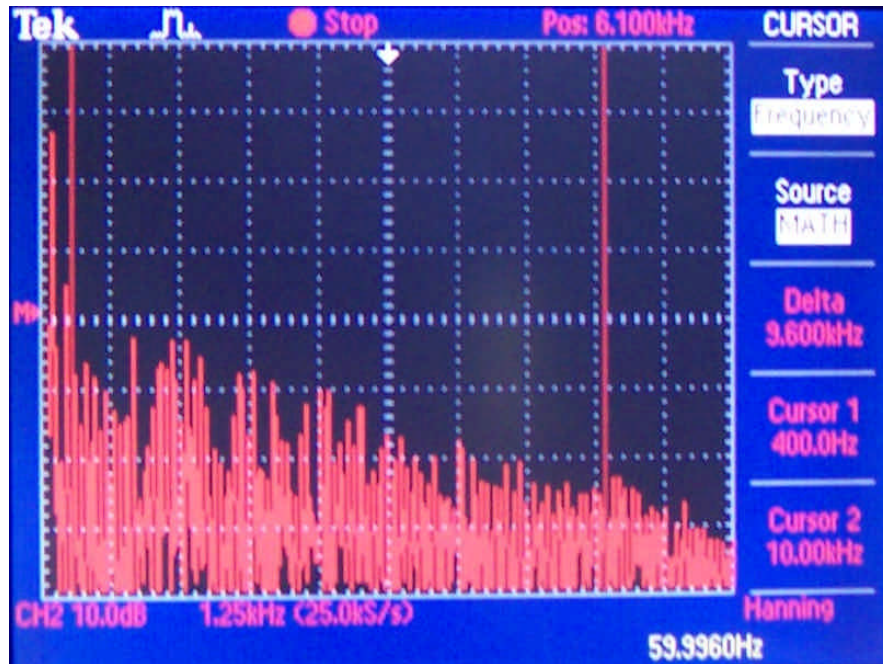

Figure 5, Spectrum of the load current of single Stetzer filter. The frequency span is from 0 Hz to 12.5 kHz

The conversion factor for the AC current probe is 100mV/A and the root mean square (RMS) voltage on the blue trace of Figure 4 is approximately $2.5 \times 50\text{mV} \times 0.707$ giving a load current of approximately 0.9 amperes (A). If one calculates the load current of a 20 microfarad capacitor connected across 120 V, it equals 0.90 A.

From the oscillograph of Figure 4 one can see considerable distortion of the Stetzer filter load current. The spectral plot (Figure 5) shows significant frequency components (spectral lines) well in excess of 10 kHz due to the filter. These results were consistent for both of the two filters that were available for testing.

Example: Linear load – 100 W Incandescent light bulb:

The oscillographs of the line voltage and load current of a 100 W incandescent bulb without and with a Stetzer filter plugged into the same socket are shown in Figures 6 and 7, respectively. The next two sets of measurements were performed in the Electromagnetics laboratory.

The incandescent bulb is a good example of a “linear resistive load” where the shape of the load current is an exact copy of the line voltage (Figure 6). With the Stetzer filter plugged-in, the load current (which is now the vector sum of the bulb and filter currents) appears distorted and ragged (Figure 7).

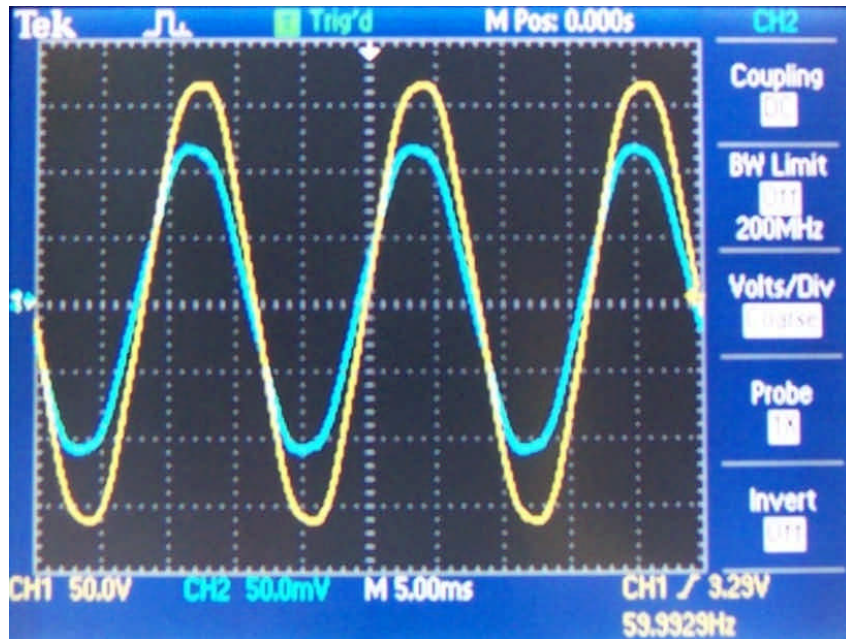

Figure 6, Line voltage (yellow) and load current (blue) of a 100 W incandescent light bulb.

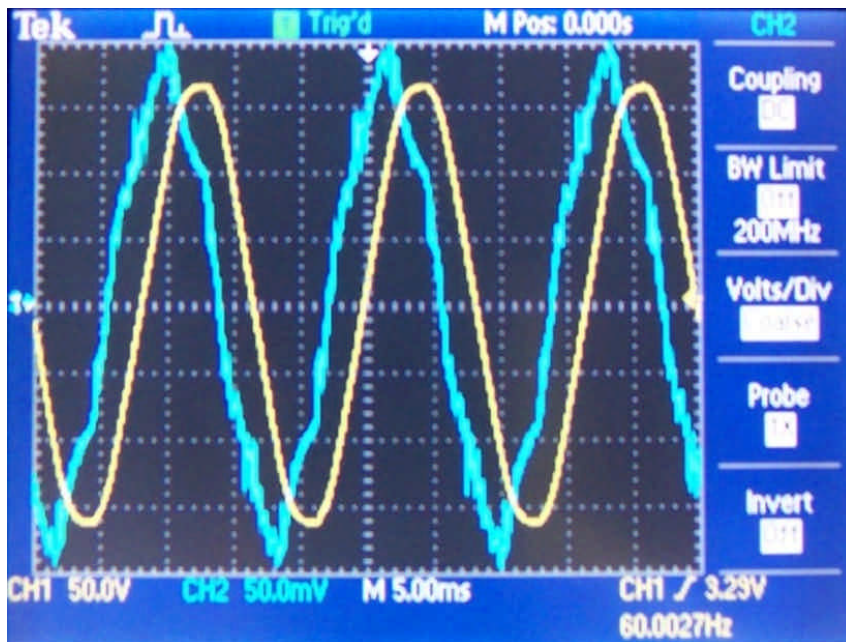

Figure 7, Line voltage (yellow) and load current (blue) of a 100 W incandescent light bulb and a single Stetzer filter.

The spectrum of the load current in Figure 7, which is not shown, contains an abundance of higher frequency components similar to the spectrum of a single Stetzer filter alone (as shown in Figure 5).

Example: Non-linear load – 22W Fluorescent Light.

Fluorescent lights are often singled out as sources of “dirty electricity”. From the oscillograph of line voltage and load current of a 22W fluorescent light (Figure 8), it can be seen that the load is non-linear, producing distortion of the current waveform. However, the distortion is confined to the smaller harmonic numbers (up to approximately the 13th) and no additional distortion of the line voltage is observed.

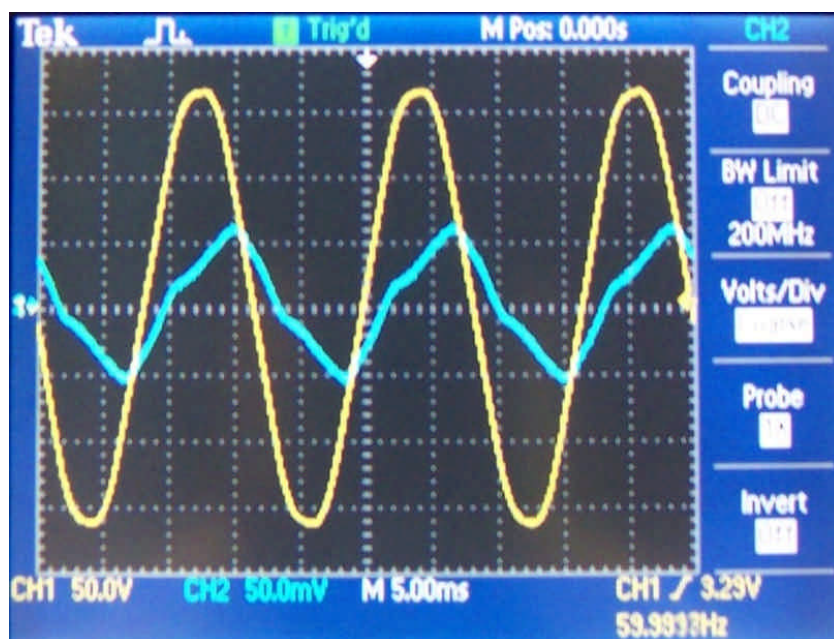

Figure 8, Line voltage (yellow) and load current (blue) of a 22W fluorescent light.

With the addition of a single Stetzer filter, the line current in Figure 9 becomes heavily distorted with a spectrum not unlike that of the Stetzer filter alone (Figure 5). Nevertheless the same basic shape of the load current of Figure 8 (fluorescent without filter) is preserved after plugging in the filter indicating that the filter is incapable of returning the current to a sinusoidal shape.

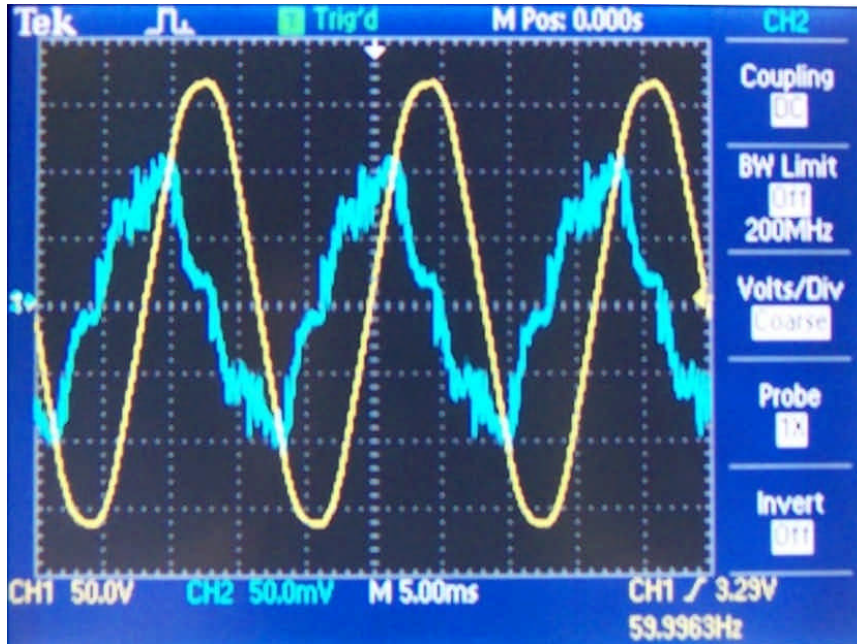

Figure 9, Line voltage (yellow) and load current (blue) of a 22W fluorescent light with a single Stetzer filter.

It is interesting to observe from these two examples and the line voltage spectra of Figures 2 and 3, that even though the load current may be heavily distorted, the line voltage does not undergo additional distortion from its original form. The reason for this lies in the extremely small “source resistance” of the electricity supply which effectively “uncouples” the line voltage from small to moderate load currents.

Example: Computer in a typical suburban home

Another often-cited source of dirty electricity is the home computer. Computers use switch-mode power supplies, which produce non-sinusoidal current waveforms. For this investigation, a computer room in a typical suburban home was used for the test site. Readings of the Graham-Stetzer Microsurge meter for various loading conditions in the computer room are shown in the table below. For these tests all other appliances were turned off.

Computer	Monitor	Stetzer Filter	Microsurge meter reading (GS Units)
OFF	OFF	UnPlugged	301-315
OFF	ON	UnPlugged	160-172
ON	ON	UnPlugged	164-180
ON	ON	Plugged	47-51
OFF	OFF	Plugged	46-52

It should be noted that the GS units continuously vary in time so that a single reading is not possible nor is a change of a few GS units significant.

The reduction in GS units with the Stetzer filter unplugged and with the monitor turned on came as a surprise. A possible explanation may be that some sort of filtering of the line voltage may be present in the monitor circuitry.

Waveforms and spectra of line voltage and load current before and after plugging the Stetzer filter are shown in Figures 10 to 12.

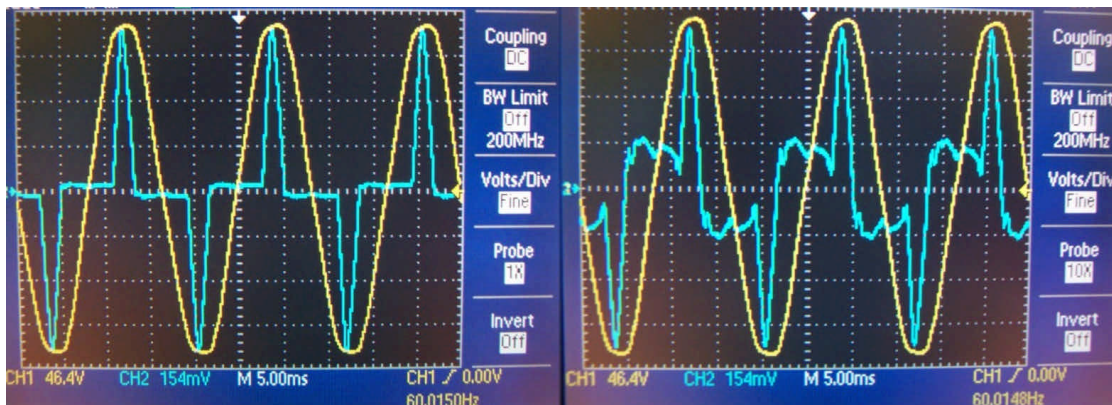

Figure 10, Line voltage (yellow) and load current (blue) of computer and monitor before (left side) and after (right side) Stetzer filter was plugged-in.

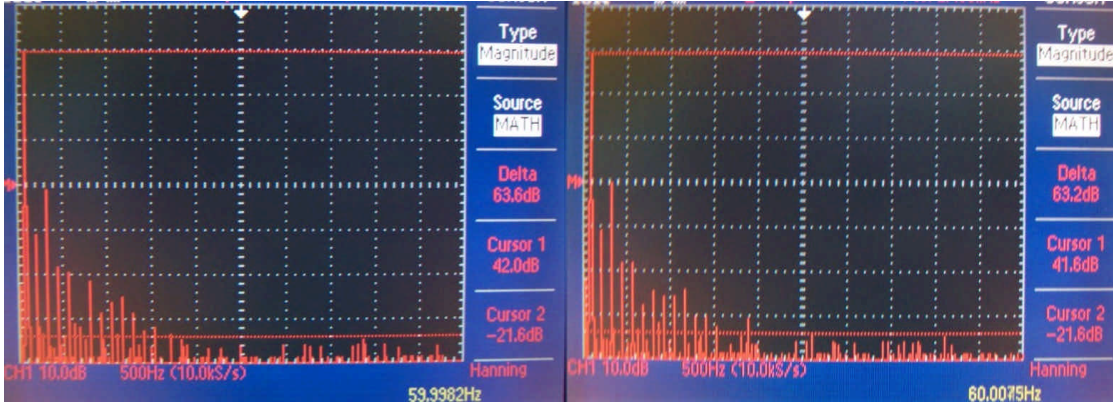

Figure 11, Spectra of line voltage of computer and monitor before (left side) and after (right side) Stetzer filter was plugged-in. Frequency spans are from 0 Hz to 5 kHz.



Figure 12, Spectra of load current before (left side) and after (right side) Stetzer filter was plugged-in. Frequency spans are from 0 Hz to 5 kHz.

As expected, the current waveform of the computer and monitor is highly distorted while the line voltage waveform remains essentially sinusoidal. Addition of the Stetzer filter introduces additional higher frequency components in the current spectrum as seen in Figure 12. Again, no comment can be made about the effectiveness of the Stetzer filter in suppressing the high frequencies in the line voltage because they are below the noise level of the instrument. Certainly there must have been some effect since the Graham-Stetzer Microsurge meter reading went down.

Discussion

The foremost observation from these measurements is that the current drawn from the electricity supply by the Stetzer filter appears to be heavily distorted. It possesses harmonic frequencies well in excess of 10 kHz, which would otherwise not exist if it weren't for the filter. These currents add (in a vector fashion) to the load currents drawn by the appliances in a house and are a significant source of "dirty electricity" in their own right. Originally it was thought that the added distortion was due to non-linearities in the capacitors used in the manufacture of the filters. A subsequent investigation into this showed that the same distortions occurred for a number of different capacitor types and values leading to the suspicion that the cause of the distortions is due to something else.

Further insight can be gained from examining the Thevenin equivalent circuit of the electricity supply with a Stetzer filter installed [Fink, 1975, Ch3, p10]. The Thevenin equivalent open-circuit voltage V_{oc} has the form:

$$V_{oc} = V_{line} / (1 + j\omega R_s C)$$

while the Thevenin equivalent series impedance R_{Th} is:

$$R_{Th} = R_s / (1 + j\omega R_s C)$$

where C = capacitance of Stetzer filter, R_s = source impedance of the electricity supply, V_{line} = line voltage, $\omega = 2\pi$ *frequency and $j = \sqrt{-1}$, the imaginary number.

The first expression shows that the line voltage is filtered by the action of the single low-pass pole, $(1 + j\omega R_s C)$. The cut-off frequency, f_c is given by the familiar:

$$f_c = 1 / (2\pi R_s C)$$

For frequencies below f_c , there is no filtering action while for frequencies above f_c , the attenuation due to the pole is 6 decibels (dB) per octave (doubling of the frequency).

The value of R_s is critical to the setting of the cut-off frequency, yet it is essentially unknown (although we suspect it is a small number). If a value of 1 ohm is assumed, then the cut-off frequency is approximately 8 kHz. This is twice the frequency claimed by the vendor of the Stetzer filter to be the frequency at which the filter begins to have an effect. This would put their estimate of the source impedance around 2 ohms, by inference.

At the frequency 60 Hz and its first hundred or so harmonics, there is no filtering action and the current through the Stetzer filter, I_s , is proportional to the time-derivative of the voltage across it (i.e. the line voltage):

$$I_s = C (dV_{\text{line}}/dt)$$

If the line voltage is written as a Fourier series in time:

$$V_{\text{line}}(t) = V_1 \sin(\omega t) + V_2 \sin(2\omega t) + V_3 \sin(3\omega t) + \dots$$

the filter current is then:

$$I_s = \omega C [V_1 \cos(\omega t) + 2V_2 \cos(2\omega t) + 3V_3 \cos(3\omega t) + \dots]$$

where $\omega = 2\pi(60)$ radians per second, t is the independent time variable and the coefficients V_i represent the amplitudes of the voltage spectral components at the harmonic frequencies ω , 2ω , 3ω and so on. From this, one can see that successive spectral amplitudes of the Stetzer filter current undergo a multiplication by the harmonic number. For instance the 10th harmonic component of the current will be 10 times the relative amplitude of the 10th harmonic component of the line voltage. In this way, the higher frequency harmonics of the line voltage are enhanced in the filter's current waveform. It is believed that this accounts for the distorted look of the current waveforms in the results and not so much due to non-linearities of the capacitor.

To see this effect quantitatively, the first 13 odd-numbered harmonics were measured for both the line voltage and Stetzer filter current. (Note that only odd harmonics were observed in the spectra.) For each harmonic frequency, the ratio $I_i / (2\pi * 60 * C * V_i)$ was computed where I_i is the spectral current amplitude at harmonic frequency $60 * i$ and C is the capacitance of the Stetzer filter, 20 microfarads. The result for each spectral component should be equal to the harmonic number. The results are shown in the table below. They indicate good correspondence for the 5th, 7th and 11th harmonics. It was observed that the 3rd and 9th harmonics of the current were much lower than expected.

Harmonic frequency	Harmonic number	Voltage dBV	Voltage Vrms	Current Probe dBV	Current Probe V rms	Stetzer Current A rms	Calculated harmonic no. $I/(2\pi * 60 * C * V)$
60	1	41.2	114.815	-21.2	0.08710	0.8710	1.01
180	3	-8.02	0.397	-66.4	0.00048	0.0048	1.60
300	5	7.18	2.286	-41.6	0.00832	0.0832	4.83
420	7	-8.02	0.397	-52.4	0.00240	0.0240	8.01
540	9	-12	0.251	-62	0.00079	0.0079	4.19
660	11	-11.2	0.275	-53.2	0.00219	0.0219	10.54
780	13	-18.8	0.115	-57	0.00141	0.0141	16.32

This explanation is further confirmed by another demonstration. A Stetzer filter was connected across the output of a Wavetek Model 166 Function Generator that was set to

an output of 15 V peak at 60 Hz. This generator has a source impedance of 50 ohms and a relatively pure voltage waveform (i.e. low distortion). The amplitude ratio of the fundamental frequency to the largest harmonic is 55 dB as compared to the amplitude ratio of the line voltage to its largest harmonic, which is only 34 dB. An oscillograph of the voltage and current waveforms are shown in Figure 13.

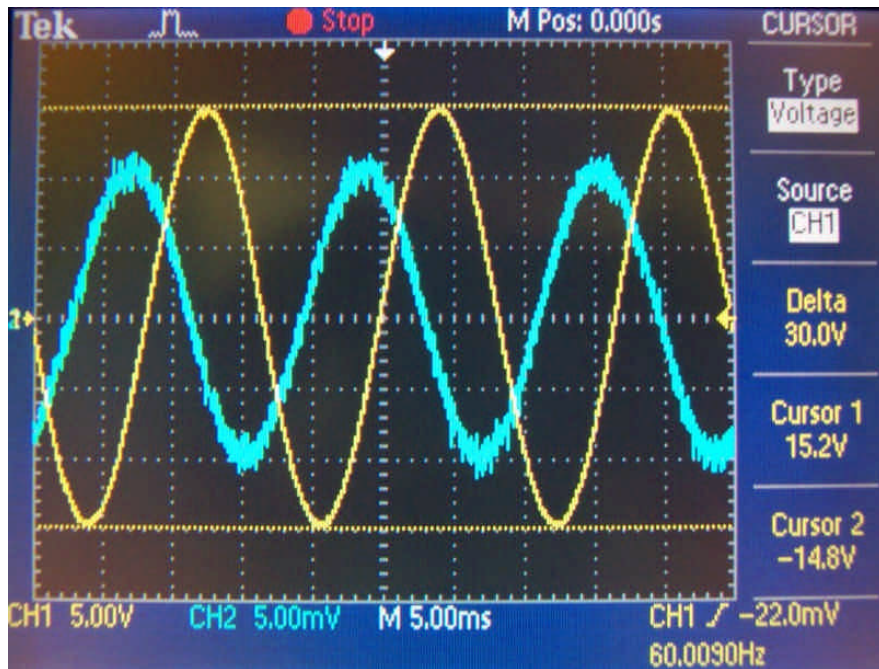

Figure 13, Voltage (yellow trace) and current (blue trace) waveform of Stetzer filter across output of Wavetek 166 Function Generator. The thickness of the blue trace is due to noise from the current probe, which has limited sensitivity at these small currents.

The 50-ohm source impedance gives a cut-off frequency of 160 Hz and therefore enables filtering action on all of the 60 Hz voltage harmonics. This, along with the originally low distortion of the voltage, results in a current waveform that is almost perfectly sinusoidal (although a bit noisy due to the limited sensitivity of the current probe).

Potential Sources in the 4-100 kHz Frequency Band:

From the preceding we see that the Stetzer filter can only attenuate the higher frequencies on the line voltage and not the ones that appear to be of considerable amplitude, that is the lower harmonics of the line frequency. The question arises then, what possible sources could induce significant spectral content in the 4 kHz to 100 kHz band on the

electricity supply? Commercial broadcast radio is unlikely since AM starts at 540 kHz, FM at 88 MHz and television starts at 54 MHz. The Canadian Table of Frequency Allocations [<http://strategis.ic.gc.ca>] lists mostly maritime fixed and mobile communications applications in the 4- 100 kHz band, which may be a factor if you lived on one of the coasts. Also, there is thermal noise on the system due to thermal agitation of molecules. This noise is also known as “white noise” or “static” and is familiar to anyone who has listened to a radio that has been tuned away from a station.

Transient disturbances for indoor type 120 to 240 V AC systems are known to have frequency content in the 30 Hz to 100 kHz band [Whitaker, 1991, pp62-66]. These can occur from load switching, power factor capacitor switching as well as lightning strikes, to name a few. However, these phenomena do not occur frequently as noted in the Canadian Electricity Association’s National Power Quality Survey, which found an average of 184 transient disturbances per month [CEA 1995]. This translates to about one transient disturbance every 4 hours on an average basis.

According to [Whitaker, 1991], capacitors are sometimes used for transient suppression, however they may cause unwanted oscillation or ringing of the line voltage as a result of interaction with the inductance in AC systems. Typical values are in the range 0.001 to 0.1 microfarad [Whitaker, 1991, pp188-189]. Testing whether a Stetzer filter would be effective in mitigating transient disturbances would require specialized equipment that simulates the disturbances because they occur randomly and infrequently. This is beyond the capabilities of our laboratory.

Body Interactions:

Even without a Stetzer filter installed, our measurements at both locations showed no spectral content in the 4 kHz to 100 kHz band to a level of 1500 times below the amplitude of the 60 Hz line voltage. (This was the “noise floor” of our instrument.) The question arises then; what significance are any potential high frequencies on the line voltage to the mix of endogenous (naturally occurring) and externally induced voltages and currents in our bodies?

To answer this, we need to go back to first principles. The scientifically accepted response of a biological organism to the interaction with an external electrical charge or current is the in-situ electric field or tissue current density [Bronzino, 1995, pp 1396-1398]. The two are related through the tissue conductivity and are interchangeable as measures of an internal dose. This is valid no matter whether biological effects result or not. The way scientists simplify the process of accounting for all the variables inherent in describing the interaction is to make use of the concept of electric and magnetic fields. For instance, an electric charge creates an electric field around it. In an organism exposed to that field, in-situ electric fields and tissue current densities are induced. Similarly for magnetic fields, which are produced by electric currents, in-situ electric fields and tissue current densities are also induced. In-situ electric fields can be thought of as internal voltages (actually voltage gradients) while tissue current densities can be thought of as internal currents.

Electric and magnetic fields do not induce internal fields and currents in the body the same way. An electric field of 25-2000 V/m (depending primarily on the orientation of the body relative to the field) is required to produce internal currents similar in strength to those induced by an external 1 microTesla magnetic field for frequencies up to 100 kHz. [Kaune, 1997]. Also, it has been pointed out by many scientific commentators that the most likely agent for biological and/or adverse health effects is the magnetic field.

A rough estimate of the significance of the high frequency components of the line voltage can be made if we assume that the spectrum of the electric field in the house is the same as the line voltage. Measurements indicate that average ambient 60 Hz electric fields in the house are in the vicinity of 1-2 V/m [CEA 1991, p10]. According to Table 5 in [Kaune, 1997] a value of 2 V/m at 60 Hz induces an internal electric field of 19×10^{-5} V/m. Assuming that a voltage component at 100 kHz is 1500 times below the one at 60 Hz, it will induce an internal electric field of 6.3×10^{-5} V/m according to the same table. Clearly the coupling of external electric fields to the body increases with increasing frequency, however the small amplitudes of the high frequency components limits their contribution to the mix of induced fields and currents in the body.

Finally one must examine the frequency content of endogenous (naturally occurring) fields and currents. EEG (electroencephalogram) voltages have frequencies up to 10 Hz. ECG (electrocardiogram) frequencies lie in the range 0.05 Hz to 100 Hz, sometimes up to 1 kHz. Nerve excitation or action potentials have frequencies up to 10 kHz [Marino, 1988, pp345-361]. Most endogenous processes operate at relatively low speeds, which have frequency content below 10 kHz. So it would seem that the high frequencies on the electrical supply in the range of 4 kHz to 100 kHz would be less likely to interfere with biological processes than the lower ones which are totally unaffected by the Stetzer filter.

Conclusions

The purpose of this report was to assess the impact of Stetzer Filters on the electricity supply in the home, in particular to look at its claims to reduce the “dirty electricity” in the line voltage within the specified range of 4kHz to 100kHz. It is important to note that these filters do not claim to reduce magnetic fields at any given frequency.

We conclude the following:

- 1) The Stetzer filter draws 0.9 amperes of reactive current on its own therefore increasing the amount of current supplied to the home, increasing the burden on the electricity supply and increasing ambient magnetic field levels in the house. The amount of increase may be large or small depending on the number of filters installed.
- 2) The Stetzer filter does not clean up line voltage harmonics. Nor does it help to restore the current of a non-linear load back to a sinusoidal shape. The Stetzer filter current is highly distorted containing harmonic content up to 10 kHz. (Stetzer current harmonics are accentuated versions of the line voltage harmonics.) Since Stetzer filter currents add vectorily to the other load currents in the home, their distortion products (harmonics) are carried on the electricity supply and add to the level of “dirty electricity” in the house.
- 3) The Stetzer filter is probably effective in attenuating high frequency (4kHz to 100 kHz) noise on the AC power lines although these components are small to begin with. No assessment can be made concerning its effectiveness in suppressing transient disturbances since these phenomena are random, infrequent events for which we are unable to test.

The impact of installing one Stetzer filter on an outlet has no financial effect on the homeowner since capacitive or inductive (reactive) loads are out of phase with the line voltage and do not consume energy. Consumers only pay for resistive load currents that are in phase with the line voltage. However, the electricity provider must generate the additional current and carry it on the network. An example of this impact would be as follows. In a community of 100,000 homes, if 25,000 homeowners decided to equip their homes with 20 filters per household (20 x 0.9amperes), this would add a constant demand on the network of 450,000 amperes reactive. In some situations, this could lead to the requirements of additional transmission facilities (towers) and would translate to higher magnetic field exposure in proximity to the towers.

Bibliography

Bronzino J.D. (Ed.), "The Biomedical Engineering Handbook", CRC Press, Inc., Boca Raton, FL, (1995)

CEA (Canadian Electrical Association), "Measurement of Electric and Magnetic Fields, Main Report", Report No. 272 T 677, (1991)

CEA (Canadian Electrical Association), "Power Quality National Survey", Report No. 220 D 711 A, (1995)

Fink (Ed.), "Electronics Engineers' Handbook, First Edition", McGraw-Hill Inc., New York, NY, Chapt 6, pp 66, (1975)

Havas M and Stetzer D, "Dirty Electricity and Electrical Hypersensitivity: Five Case Studies", World Health Organization Workshop on Electrical Hypersensitivity, 25-26 October, Prague, Czech Republic, (2004)

ICNIRP, "Guidelines for limiting exposure to time-varying electric, magnetic and electromagnetic fields," Health Physics, April 1998, Vol. 74, Number 4, pp 494-522

Kaune WT, Guttman JL and Kavet R, "Comparison of coupling of humans to electric and magnetic fields with frequencies between 100 Hz and 100 kHz," Bioelectromagnetics 18:67-76 (1997)

Marino AA, (Ed.), "Modern Bioelectricity", Marcel Dekker, Inc., New York, NY, (1988)

Whitaker, JC, "AC Power Systems handbook", CRC Press, Inc, Boca Raton, FL, (1991)